

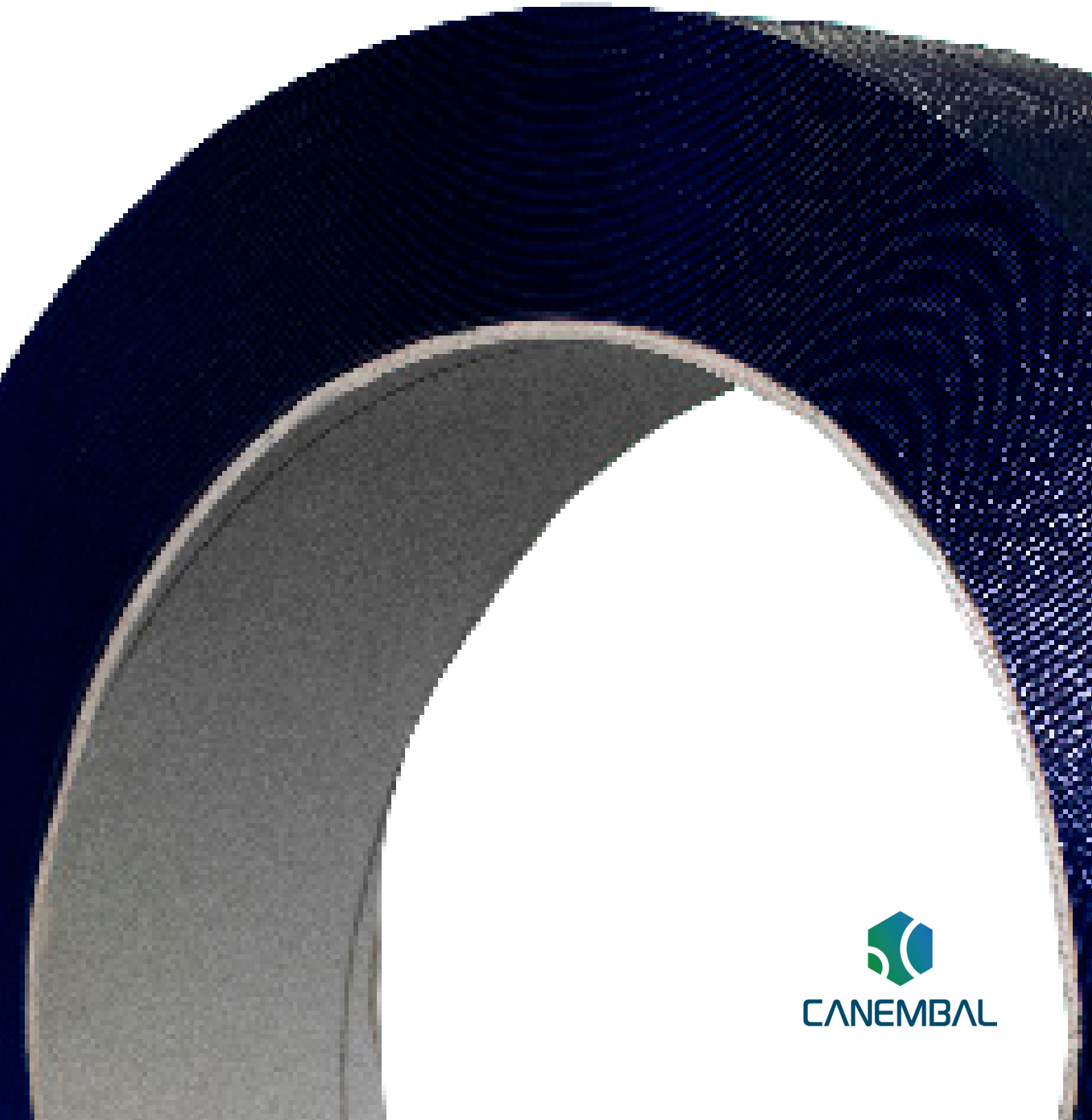

Polyester Straps

Technical and Commercial sheet



CANEMBAL



Description

A strap is a continuous tape made of different materials, such as polypropylene, polyester, etc.

It is used in industry or in the transport of goods for securing loads, or in construction as a fastening element. Its materials and dimensions vary depending on its field of application.



Advantages

- Secures and stabilises the load
- Prevents material damage during handling.
- Easy handling, storage and transport.



Applications

The application of polyester (PET) strapping can be semi-automatic or automatic.

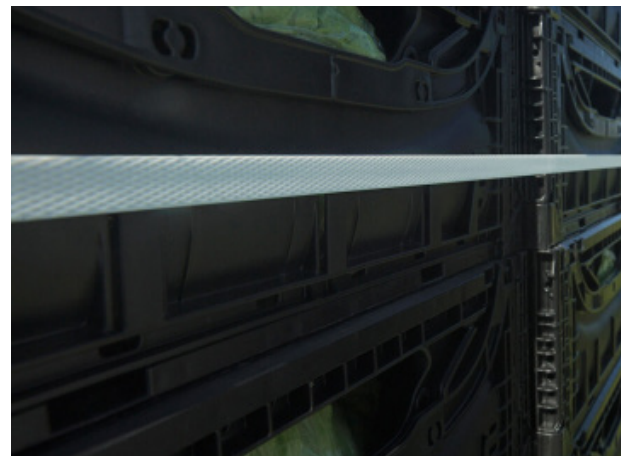

Storage

Strapping should be protected from adverse conditions and stored indoors.



Recommendations

Polyester (PET) strapping is best recommended for goods that need to be stored outdoors, in cold storage or refrigeration.



Printing

One or two inks.

TECHNICAL SHEET

Components

Material made of polyester fibres (PET)

	Width (mm)	Thickness (mm)	Surface	Inner Diameter (mm)	Elongation (%)
Semi-automatic	11 (+10,5/-10)	0,5 (-0,47/+0,53)	Embossed	200 (+2/-1 mm)	15% (+/-5%)
Automatic	10, 11, 12, 15 (+10,5/-10)	0,5 - 0,6 (-0,47/+0,53)	Embossed	406 (+2/-1 mm)	Min. 11%

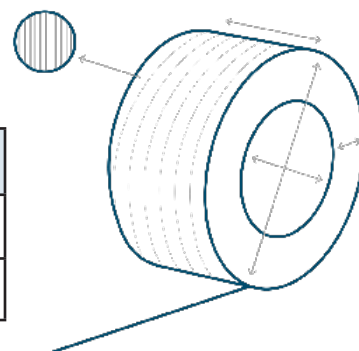

* Please contact us for any other dimensions on request.

Quality standard

UNI EN ISO 9001



* For other colours, please contact your sales representative.

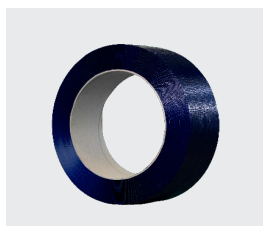

Automatic straps

Use: automatic machines.



Semi-automatic strap

Use: semi-automatic machines.

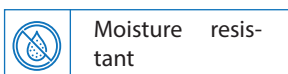

Moisture resistant



Recyclable



Customisable

Complementary Products



Corner boards

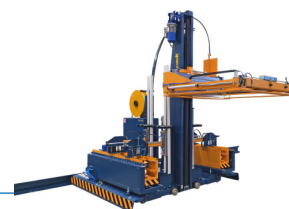

Strapping machines

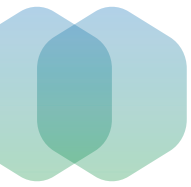

UNITS / PALLET

Logistical data

	PET STRAPPING	Automatic PET strapping
Coils / Box	-	2
Meters / Coil	4100 (+/-3%)	2800 (+/-3%)
Coils/ Pallet	48	30

